

# Active and semi active Vibrations Control

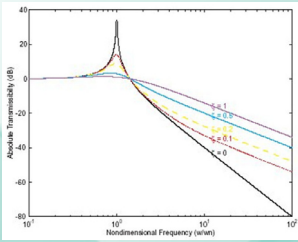

Undesired noise and vibrations are since ever a major problem in many human activities and domains. Airplanes, space trusses and satellites, cars, machine tools and large bridges, all can be disturbed in their normal functions by vibrations and noise. As the actuators play a crucial role in active control of vibration, the Cedrat Technologies heritage in control of these smart actuators is applied to design active structures to kill residual vibrations.

## Objective

Basically, the main advantages of the active or semi active control of vibrations are:

- Low weight and low volume,
- Adaptability even if non linear behaviour,
- Work on large bandwidth,

2 techniques called active control or semi active control can be applied. The first one can be defined as an active device which reacts on the vibrations. In this case, it can destabilize the system if the smart structure is not correctly tuned but as the system is active the response versus large bandwidth disturbances is better. The second one can be defined as a passive device in which the properties (stiffness, damping,..) can be varied in real time with a low power input. As they are inherently passive, they cannot destabilize the system.

## Some examples of smart structures

Two typical techniques called the Active Mass Dampers and the parallel structural damper can be used.

- The active mass damper:

In the first concept, a damper based on a reactive mass is mounted on the structure which be damped. The principle is to sense the vibrations with a sensor and realize a speed feedback on the actuator. Then the principal characteristic of this actuator is a perfect force generator above its resonant frequency.

The architecture of such device is composed of the mechanical part based on a magnetic technology or piezoelectric technology mastered at CEDRAT Technologies and the dedicated controller able to control the vibrations by applying the dedicated law.

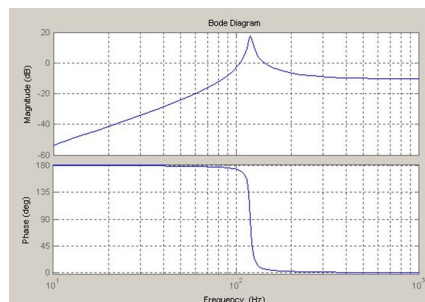

Frequency response of a actuator in proof mass configuration.

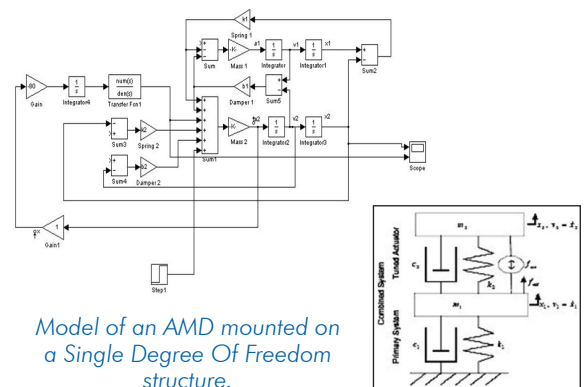

Model of an AMD mounted on a Single Degree Of Freedom structure.

# Active and semi active Vibrations Control

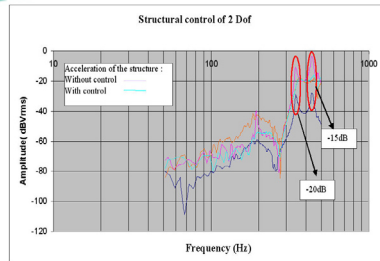
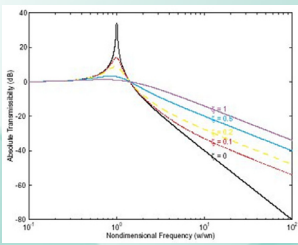

Performance and frequency response of the Active Mass Damper.

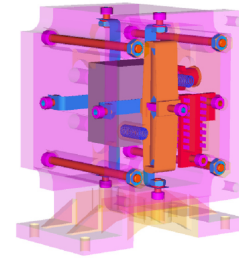

Mechanical view of the PM900M based on a APA900M piezoelectric actuator.

- Smart actuators inside an active structure:

A second solution developed at Cedrat Technologies consists in an adaptation of the structure including an actuator able to damp or to isolate a part of the structure from vibrations. In this configuration, The interaction between the actuator and the structure is close linked.

An example is built with the Rossignol SA application where the aim of the control was to reduce the vibrations at the tip of the ski.

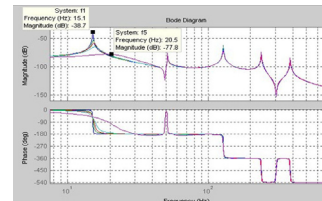
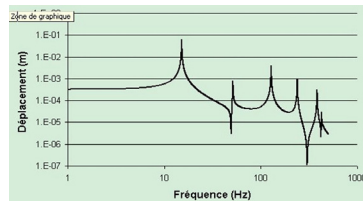

Transfer and analysis from the control point of view.

Modeling from the mechanical front of view.

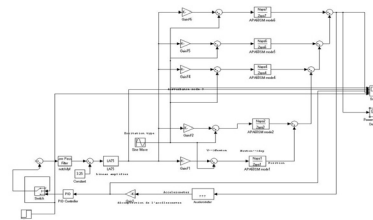
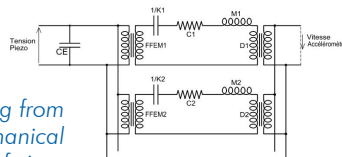

## Methodology

A strong link between the development departments of CEDRAT Technologies allows to develop the well adapted solution: the study of such system consists in the study of the stability of the control loop with a model of the structure which is damped and to analyze the performances of the loop to define the well adapted actuator in term of frequency, force, stroke. The position of the smart actuator is studied to obtain the best interaction with the structure and to avoid a uncollocated pairs sensors/actuators. Then the mechatronic study is launched to define the dedicated electronic composed of the driver of the actuator, the sensor and the controller. A complete model of the system can be built to analyze the best configurations and reduce time in the tests and integration sequence.

We can offer various actuation technologies to solve the active control of vibrations problem: we select the most appropriate technology.

## Keywords

Piezo actuators, magnetic actuator, Active mass damper, active damping, active isolation, active control of vibration, semi active control, CEDRAT.

	Displacement	Bandwidth	Force
Voice coil actuator	++	-	-
Magnetic actuator MICA	+++	+	+
MRf actuator	+++	-	0
Direct Piezo actuator PPA	-	++	++
Amplified Piezo Actuator APA	0	+	0
Magnetostrictive actuator	0	0	+

Properties of actuation technologies.